

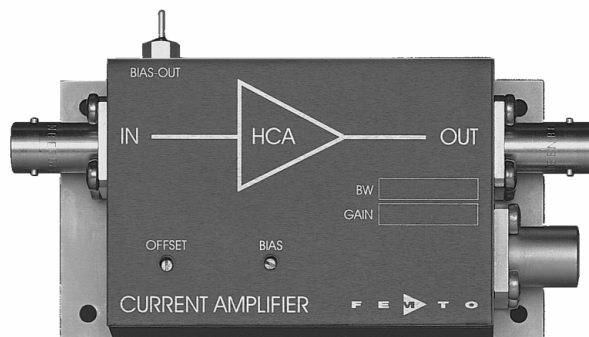

Datasheet

HCA-200M-20K-C

High Speed Current Amplifier



Features	<ul style="list-style-type: none"> • Bandwidth DC ... 200 MHz • Transimpedance (Gain) 2×10^4 V/A • Suitable for Source Capacitance up to 8 pF • Low Equivalent Input Noise Current of $4.9 \text{ pA}/\sqrt{\text{Hz}}$ 																																																											
Applications	<ul style="list-style-type: none"> • Photodiode and Photomultiplier Amplifier • Spectroscopy • Charge Amplifier • Ionisation Detectors • Preamplifier for Lock-Ins, A/D Converters, etc. 																																																											
Specifications	<table border="0"> <tr> <td></td> <td><i>Test Conditions</i></td> <td><i>$V_s = \pm 15 \text{ V}, T_a = 25^\circ\text{C}$</i></td> </tr> <tr> <td rowspan="2">Gain</td> <td>Transimpedance</td> <td>$2 \times 10^4 \text{ V/A}$ (@ 50 Ω load)</td> </tr> <tr> <td>Gain Accuracy</td> <td>$\pm 2 \%$</td> </tr> <tr> <td rowspan="5">Frequency Response</td> <td>Lower Cut-Off Frequency</td> <td>DC</td> </tr> <tr> <td rowspan="2">Upper Cut-Off Frequency (- 3 dB)</td> <td>200 MHz</td> <td>($\pm 10 \%$, @ Csource 2 to 4 pF)</td> </tr> <tr> <td>170 MHz</td> <td>($\pm 10 \%$, @ Csource 5 to 8 pF)</td> </tr> <tr> <td>Max. Source Capacitance</td> <td>8 pF</td> <td>(incl. cable, e.g. typical coax cable 1 pF/cm)</td> </tr> <tr> <td rowspan="2">Rise / Fall Time (10 % - 90 %)</td> <td>1.9 ns</td> <td>(@ Csource 2 to 4 pF)</td> </tr> <tr> <td>2.2 ns</td> <td>(@ Csource 5 to 8 pF)</td> </tr> <tr> <td></td> <td>Gain Flatness</td> <td>$\pm 0.3 \text{ dB}$</td> </tr> <tr> <td rowspan="10">Input</td> <td>Equ. Input Noise Current</td> <td>$4.9 \text{ pA}/\sqrt{\text{Hz}}$ (@ 10 MHz)</td> </tr> <tr> <td>Equ. Input Noise Voltage</td> <td>$0.9 \text{ nV}/\sqrt{\text{Hz}}$ (@ 10 MHz)</td> </tr> <tr> <td>Equ. Integrated Noise</td> <td>1.0 μA peak-peak</td> </tr> <tr> <td>Input Bias Current</td> <td>12 μA typ.</td> </tr> <tr> <td>Input Bias Current Drift</td> <td>3 nA / $^\circ\text{C}$</td> </tr> <tr> <td>Offset Current Compensation</td> <td>$\pm 100 \mu\text{A}$ adjustable by offset trimpot</td> </tr> <tr> <td>Input Current Range</td> <td>$\pm 60 \mu\text{A}$ (for linear amplification)</td> </tr> <tr> <td>Input Offset Voltage</td> <td>< 1 mV</td> </tr> <tr> <td>DC Input Impedance</td> <td>56 Ω (virtual) // 5 pF</td> </tr> <tr> <td rowspan="3">Output</td> <td>Output Voltage Range</td> <td>$\pm 1.2 \text{ V}$ (@ 50 Ω load) for linear operation and low harmonic distortion</td> </tr> <tr> <td>Max. Output Voltage Range</td> <td>$\pm 1.7 \text{ V}$ (@ 50 Ω load)</td> </tr> <tr> <td>Output Impedance</td> <td>50 Ω (terminate with 50 Ω load for best performance)</td> </tr> <tr> <td rowspan="2">Bias Output</td> <td>Bias Output Voltage Range</td> <td>$\pm 12 \text{ V}$, adjustable by bias trimpot</td> </tr> <tr> <td>Bias Output Impedance</td> <td>10 kΩ // 1 μF</td> </tr> </table>			<i>Test Conditions</i>	<i>$V_s = \pm 15 \text{ V}, T_a = 25^\circ\text{C}$</i>	Gain	Transimpedance	$2 \times 10^4 \text{ V/A}$ (@ 50 Ω load)	Gain Accuracy	$\pm 2 \%$	Frequency Response	Lower Cut-Off Frequency	DC	Upper Cut-Off Frequency (- 3 dB)	200 MHz	($\pm 10 \%$, @ Csource 2 to 4 pF)	170 MHz	($\pm 10 \%$, @ Csource 5 to 8 pF)	Max. Source Capacitance	8 pF	(incl. cable, e.g. typical coax cable 1 pF/cm)	Rise / Fall Time (10 % - 90 %)	1.9 ns	(@ Csource 2 to 4 pF)	2.2 ns	(@ Csource 5 to 8 pF)		Gain Flatness	$\pm 0.3 \text{ dB}$	Input	Equ. Input Noise Current	$4.9 \text{ pA}/\sqrt{\text{Hz}}$ (@ 10 MHz)	Equ. Input Noise Voltage	$0.9 \text{ nV}/\sqrt{\text{Hz}}$ (@ 10 MHz)	Equ. Integrated Noise	1.0 μA peak-peak	Input Bias Current	12 μA typ.	Input Bias Current Drift	3 nA / $^\circ\text{C}$	Offset Current Compensation	$\pm 100 \mu\text{A}$ adjustable by offset trimpot	Input Current Range	$\pm 60 \mu\text{A}$ (for linear amplification)	Input Offset Voltage	< 1 mV	DC Input Impedance	56 Ω (virtual) // 5 pF	Output	Output Voltage Range	$\pm 1.2 \text{ V}$ (@ 50 Ω load) for linear operation and low harmonic distortion	Max. Output Voltage Range	$\pm 1.7 \text{ V}$ (@ 50 Ω load)	Output Impedance	50 Ω (terminate with 50 Ω load for best performance)	Bias Output	Bias Output Voltage Range	$\pm 12 \text{ V}$, adjustable by bias trimpot	Bias Output Impedance	10 k Ω // 1 μF
	<i>Test Conditions</i>	<i>$V_s = \pm 15 \text{ V}, T_a = 25^\circ\text{C}$</i>																																																										
Gain	Transimpedance	$2 \times 10^4 \text{ V/A}$ (@ 50 Ω load)																																																										
	Gain Accuracy	$\pm 2 \%$																																																										
Frequency Response	Lower Cut-Off Frequency	DC																																																										
	Upper Cut-Off Frequency (- 3 dB)	200 MHz	($\pm 10 \%$, @ Csource 2 to 4 pF)																																																									
		170 MHz	($\pm 10 \%$, @ Csource 5 to 8 pF)																																																									
	Max. Source Capacitance	8 pF	(incl. cable, e.g. typical coax cable 1 pF/cm)																																																									
	Rise / Fall Time (10 % - 90 %)	1.9 ns	(@ Csource 2 to 4 pF)																																																									
2.2 ns		(@ Csource 5 to 8 pF)																																																										
	Gain Flatness	$\pm 0.3 \text{ dB}$																																																										
Input	Equ. Input Noise Current	$4.9 \text{ pA}/\sqrt{\text{Hz}}$ (@ 10 MHz)																																																										
	Equ. Input Noise Voltage	$0.9 \text{ nV}/\sqrt{\text{Hz}}$ (@ 10 MHz)																																																										
	Equ. Integrated Noise	1.0 μA peak-peak																																																										
	Input Bias Current	12 μA typ.																																																										
	Input Bias Current Drift	3 nA / $^\circ\text{C}$																																																										
	Offset Current Compensation	$\pm 100 \mu\text{A}$ adjustable by offset trimpot																																																										
	Input Current Range	$\pm 60 \mu\text{A}$ (for linear amplification)																																																										
	Input Offset Voltage	< 1 mV																																																										
	DC Input Impedance	56 Ω (virtual) // 5 pF																																																										
	Output	Output Voltage Range	$\pm 1.2 \text{ V}$ (@ 50 Ω load) for linear operation and low harmonic distortion																																																									
Max. Output Voltage Range		$\pm 1.7 \text{ V}$ (@ 50 Ω load)																																																										
Output Impedance		50 Ω (terminate with 50 Ω load for best performance)																																																										
Bias Output	Bias Output Voltage Range	$\pm 12 \text{ V}$, adjustable by bias trimpot																																																										
	Bias Output Impedance	10 k Ω // 1 μF																																																										

High Speed Current Amplifier

Specifications (continued)	<p>Power Supply</p> <p>Supply Voltage ± 15 V</p> <p>Supply Current ± 50 mA typ. (depends on operating conditions, recommended power supply capability minimum ± 150 mA)</p> <p>Case</p> <p>Weight 210 g (0.5 lbs)</p> <p>Material AlMg4.5Mn, nickel-plated</p> <p>Temperature Range</p> <p>Storage Temperature -40 ... +100 °C</p> <p>Operating Temperature 0 ... +60 °C</p>
Absolute Maximum Ratings	<p>Input Voltage ± 5 V</p> <p>Power Supply Voltage ± 22 V</p>
Connectors	<p>Input BNC</p> <p>Output BNC</p> <p>Power Supply LEMO series 1S, 3-pin fixed socket</p> <p>Pin 1: + 15V</p> <p>Pin 2: - 15V</p> <p>Pin 3: GND</p>

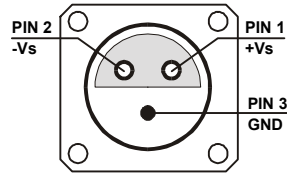

Application Diagrams

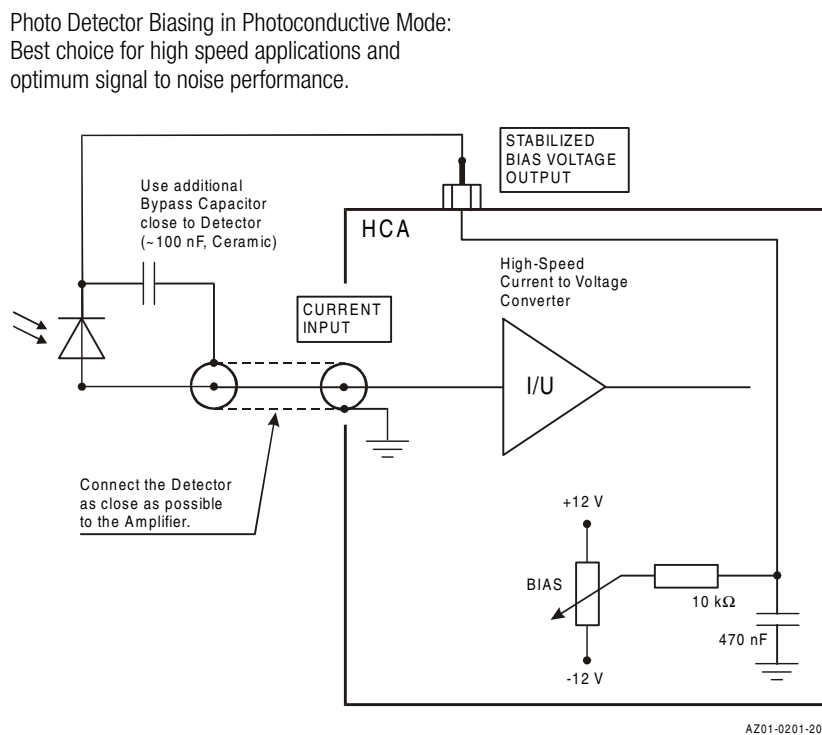

High Speed Current Amplifier

Typical Performance Characteristics

Frequency Response

Offs 5.1 dB RBW 3 MHz
 Att 0 dB * VBW 1 kHz M1[1] -3.00 dB
 Ref -23.4 dBm SWT 660ms 210.48000000 MHz

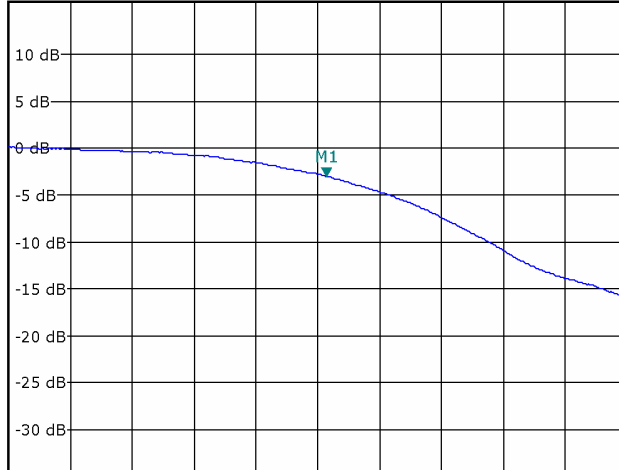

Start 10.0 MHz Stop 400.0 MHz

Noise Spectrum

* RBW 1 MHz
 Att 0 dB * VBW 1 kHz Noise1 96.560999 nV/√Hz
 Ref 7.1 mV SWT 800ms 10.00000000 MHz
 Noise2 208.012239 nV/√Hz
 200.00000000 MHz

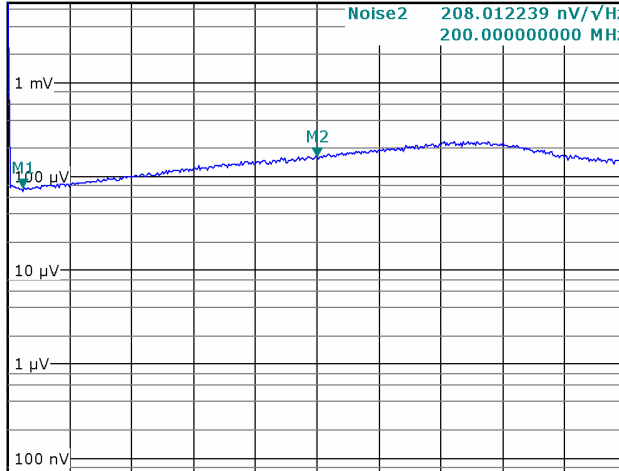

Start 0.0 Hz Stop 400.0 MHz

Note: Spectral noise data is measured at the amplifier output with open but shielded input. To determine the spectral input noise divide the measured output noise by the amplifier gain of 2×10^4 V/A, i.e.:

Marker	Frequency	Output Noise	Resulting Input Noise
1	10 MHz	97 nV/√Hz	4.9 pA/√Hz
2	200 MHz	208 nV/√Hz	10.4 pA/√Hz

High Speed Current Amplifier

Typical Performance Characteristics (continued)

Pulse Response to Square Wave Input Signal (with 16 times averaging)

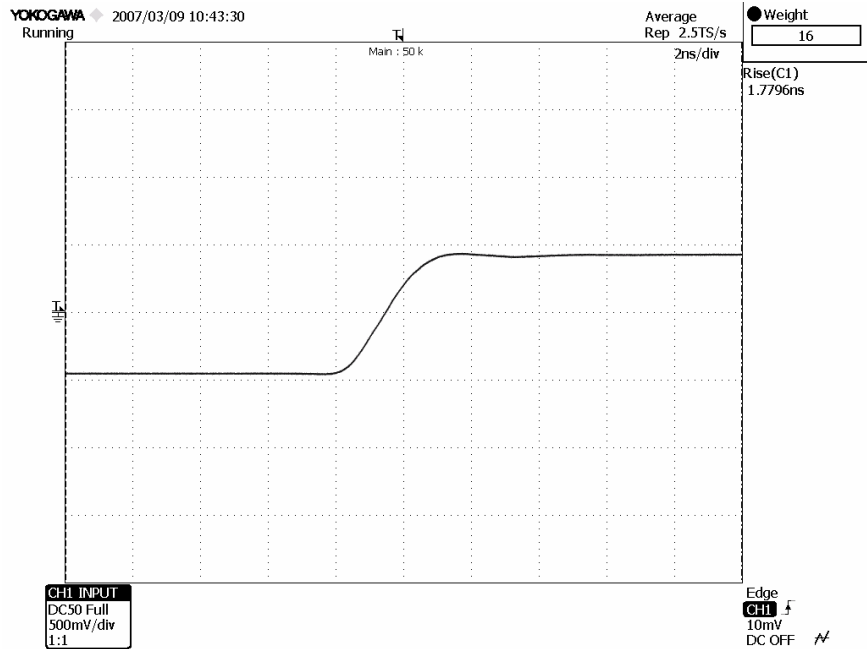

Large Signal Response output signal for 100 MHz, 50 μ A peak-peak input signal (with 4 times averaging)

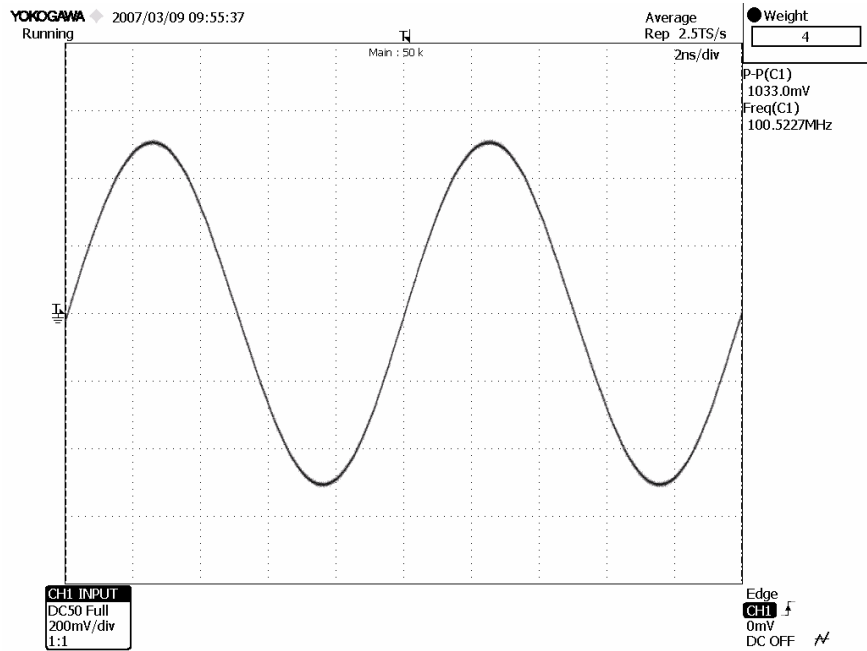

High Speed Current Amplifier

Typical Performance Characteristics (continued)

Small Signal Response
output signal for 1 MHz, 1 μ A peak-peak square wave input signal
(without (top) and with 64 times averaging (bottom))

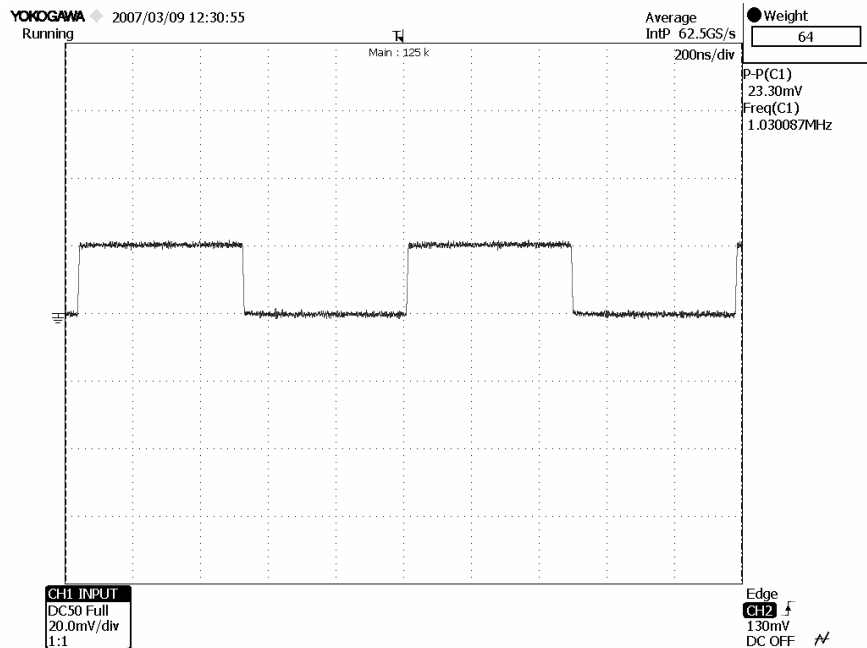
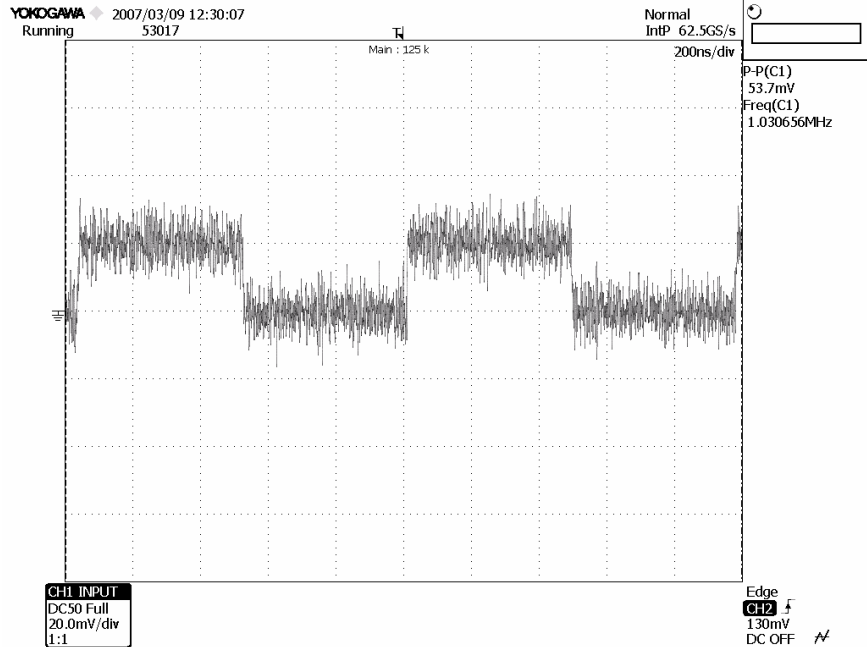

High Speed Current Amplifier

Dimensions

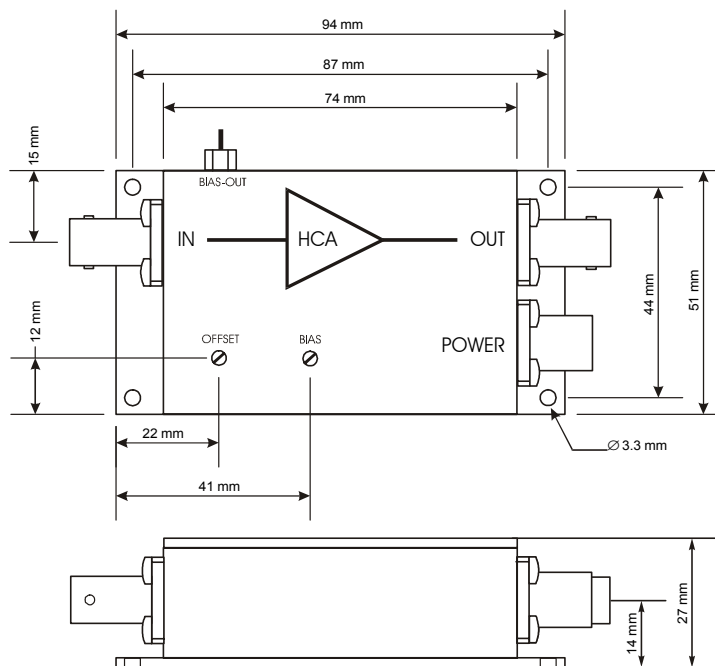

DZ01-0201-22

FEMTO Messtechnik GmbH
 Klosterstr. 64
 D-10179 Berlin · Germany
 Tel.: +49-(0)30-280 4711-0
 Fax: +49-(0)30-280 4711-11
 e-mail: info@femto.de
 http://www.femto.de

Specifications are subject to change without notice. Information furnished herein is believed to be accurate and reliable. However, no responsibility is assumed by FEMTO Messtechnik GmbH for its use, nor for any infringement of patents or other rights granted by implication or otherwise under any patent rights of FEMTO Messtechnik GmbH. Product names mentioned may also be trademarks used here for identification purposes only.
 © by FEMTO Messtechnik GmbH
 Printed in Germany