

## DL-3038-033

Wellenlänge: 635nm (typ.)  
 Geringer Schwellstrom: 40mA (typ.)  
 Niedrige Betriebsspannung: 2,2V typ.



**Anwendungsgebiete:**  
 Laserpointer  
 Laserwasserwaagen

### Maximalwerte

Parameter		Symbol	Wert	Einheit
Ausgangsleistung	CW	Po	5	mW
	Laser	VR	2	V
Sperrspannung	Laser	VR	2	V
	PIN	VR	30	V
Betriebstemperatur		Topr	-10...+50	°C
Lagertemperatur		Tstr	-40...+85	°C

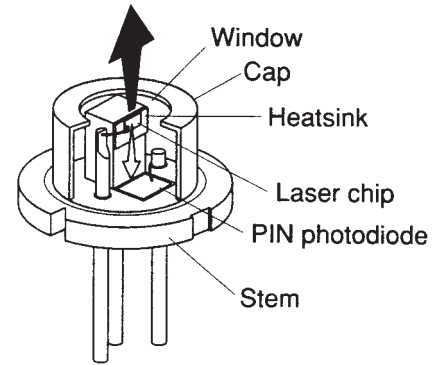

### Elektrische und optische Eigenschaften bei 25°C

Parameter	Symbol	Betriebsbedingung	Min.	Typ.	Max.	Einheit	
Schwellstrom	I <sub>th</sub>	CW	---	30	50	mA	
Betriebsstrom	I <sub>op</sub>	Po=5mW	---	40	60	mA	
Betriebsspannung	V <sub>op</sub>	Po=5mW	---	2,2	2,4	V	
Wellenlänge		Po=5mW	---	635	640	nm	
Strahldivergenz	Senkrecht	⊥	---	25	30	35	deg.
	Parallel	∥	---	6	8	10	deg.
Strahlabweichung	Senkrecht	⊥	---	---	+/-3	deg.	
	Parallel	∥	---	---	+/-3	deg.	
Differentieller Wirkungsgrad	dPo/dI <sub>op</sub>	Po=5mW	---	0,4	---	mW/mA	
Monitordiodenstrom	I <sub>m</sub>	Po=5mW	0,15	0,3	0,65	mA	
Astigmatismus	As	Po=5mW	---	8	---	µm	

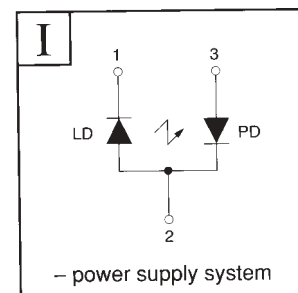
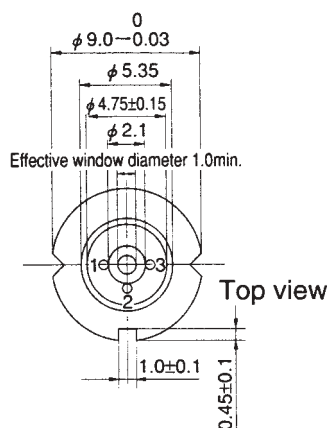
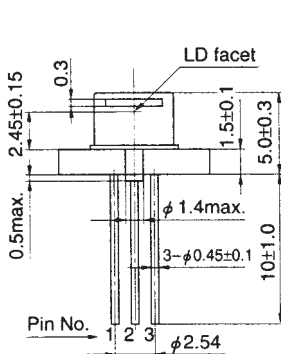

# Characteristics

Output power vs. Forward current

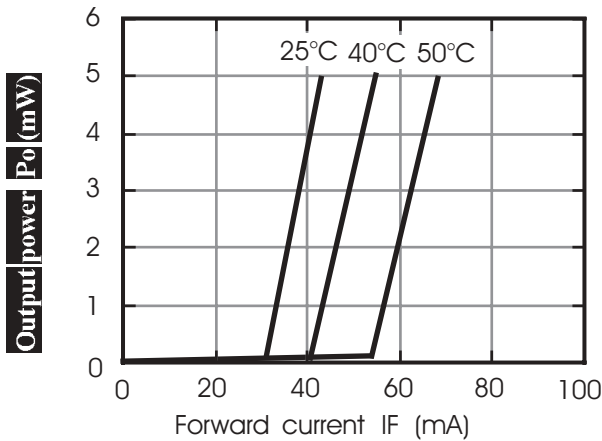

Threshold current vs. Temperature

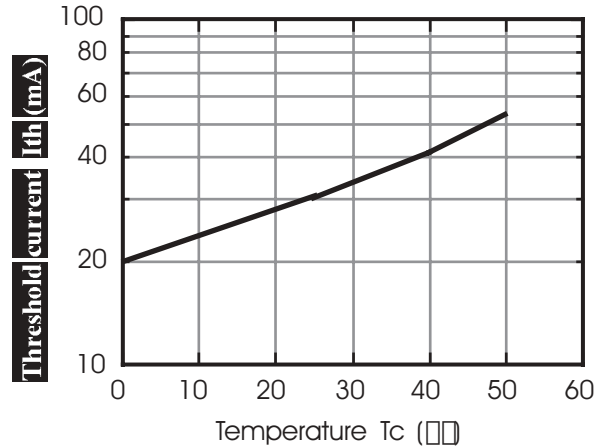

Monitoring current vs. Output power

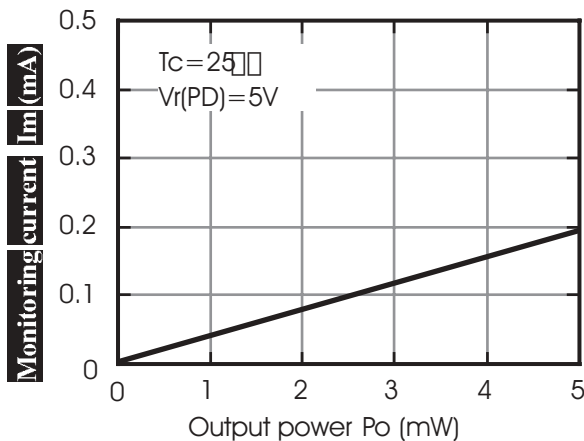

Beamdivergence

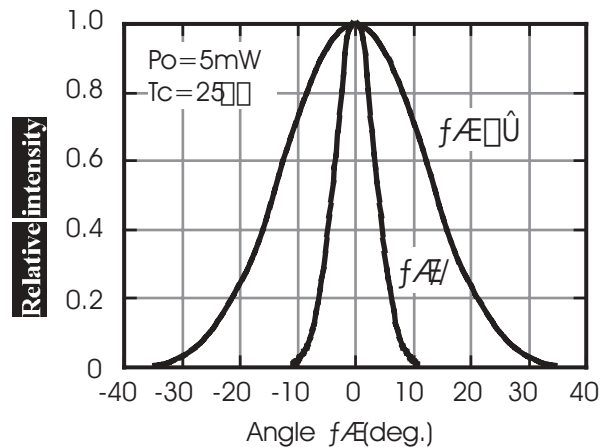

Lasing wavelength vs. Temperature

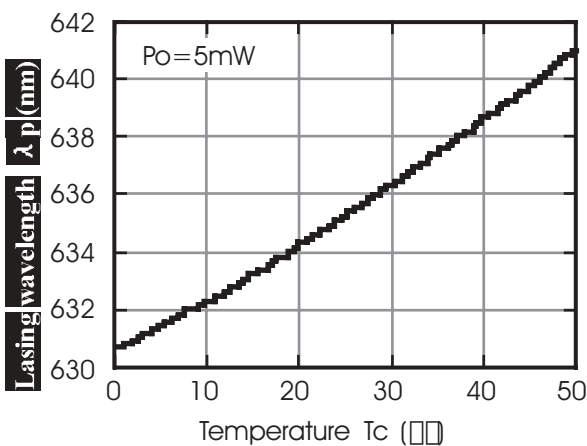

Lasing wavelength vs. Output power

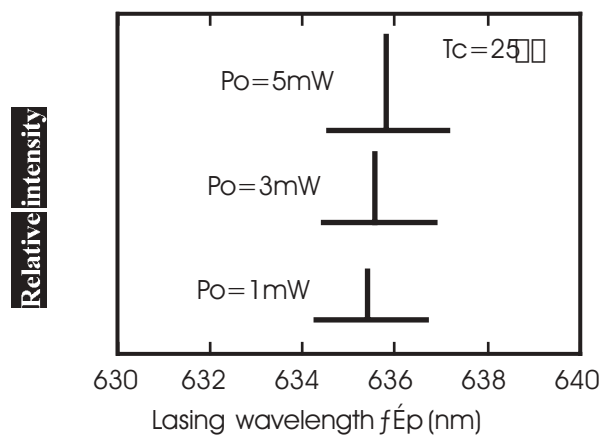

This is typical data and it may not represent all products.