

# LME-541-#

3.0 x 3.0 mm<sup>2</sup> pyroelectric IR detector  
CMOS preamplifier

## Description: LME-541-#

[# = extension code]

single element, area 3.0x3.0mm<sup>2</sup>, ultra low microphonic effect;  
for current mode, with micro power OpAmp; feedback R 24GOhm ±10% // C 0.20±0.1pF; high gain

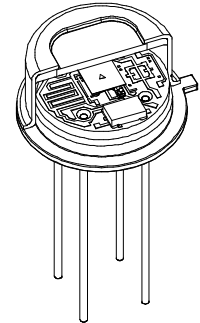

## Housing:

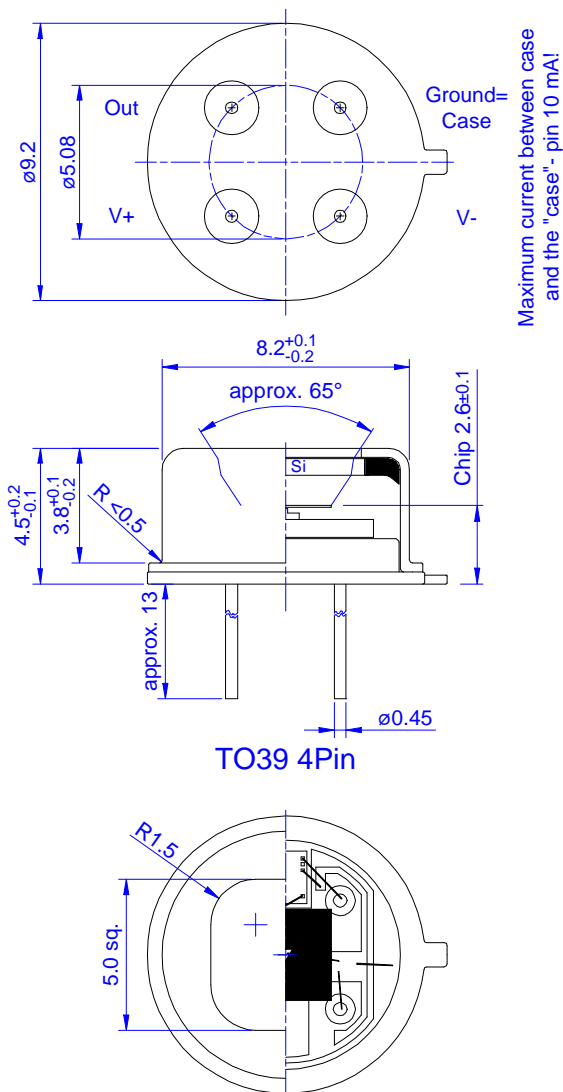

## Pin assignment:

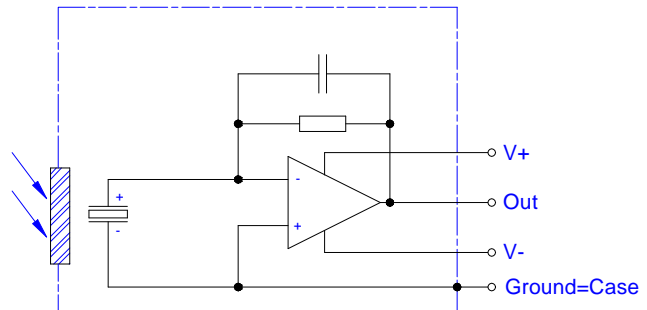

Standard Products

## Frequency response:

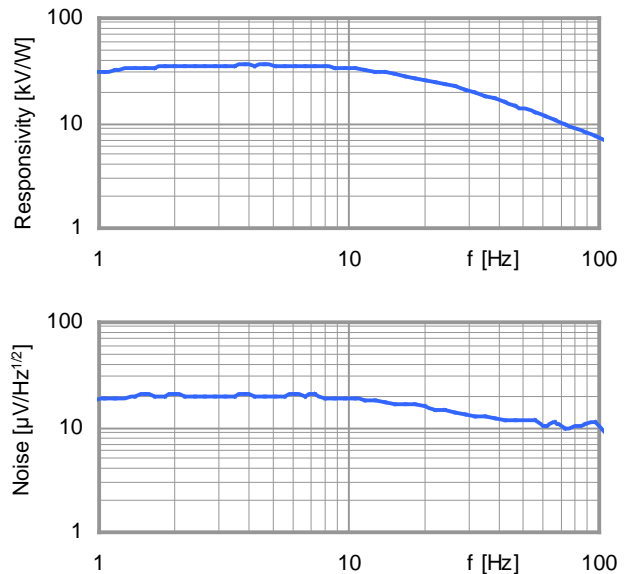

**InfraTec GmbH**  
Infrarotsensorik und Messtechnik  
Gostritzer Str.61-63  
01217 Dresden / Germany  
E-Mail: sensor@InfraTec.de  
http://www.InfraTec.de

distributed by:

**ELECTRO OPTICAL COMPONENTS, Inc.**  
5460 Skylane Blvd.  
Santa Rosa, California 95403



Tel: 707-568-1642  
Fax: 707-568-1652  
E-Mail: info@eoc-inc.com  
http://www.eoc-inc.com

## LME-541-#

3.0 x 3.0 mm<sup>2</sup> pyroelectric IR detector  
CMOS preamplifier

Test circuit:

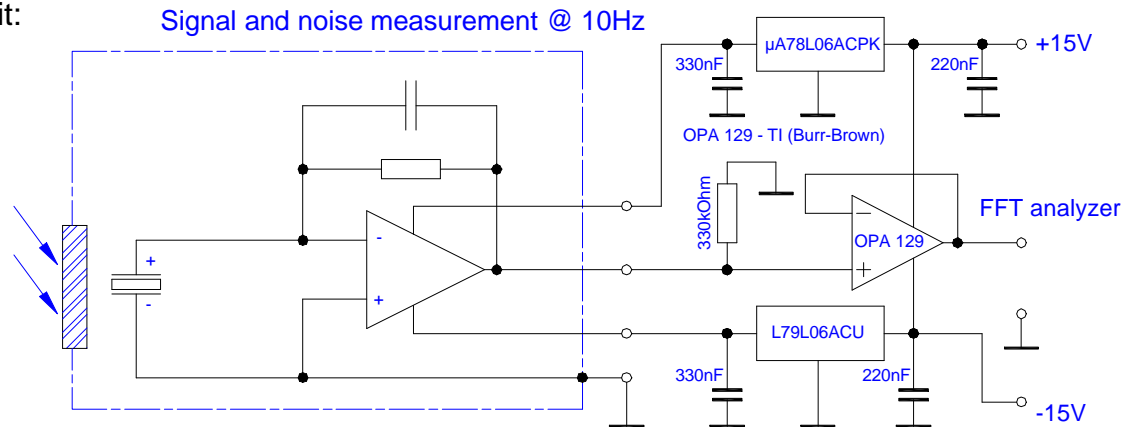

Parameters:

Element size / type	nom	3.0x3.0 mm <sup>2</sup> lithium-tantalate with black layer
Aperture	nom	5.0 mm sq.
Thermal time constant	typ	200 ms
Feedback resistor	nom	24 GOhm ±10%
Feedback capacitor	nom	0.2±0.1 pF
Polarity	nom	negative signal by positive IR flux change
Voltage Responsivity {500K, 10Hz, 25°C, without window}	min	28,000 V/W
Noise density {10Hz, BW 1Hz, 25°C}	max	25 μV/Hz <sup>1/2</sup>
Detectivity {500K, 10Hz, 1Hz, 25°C, without window}	min	3.3*10 <sup>8</sup> cmHz <sup>1/2</sup> /W
Acceleration response {5 ... 200Hz}	typ	300 μV/g; g=9.81m/s <sup>2</sup>
CMOS operational amplifier	nom	OpAmp2 (for characteristics see application note)
Supply voltage V <sup>+</sup> - V <sup>-</sup>	max	16 V
Operating supply voltage V <sup>+</sup> / V <sup>-</sup>		+2.2 ... 8.0 V / -2.2 ... -8.0 V
Recommended supply voltage	nom	V <sup>+</sup> = +5 V; V <sup>-</sup> = -5 V
Supply current {output load 1MOhm}	max	150 μA
Offset voltage {25°C; output load 1MOhm}		-5 mV ... +5 mV
Optimal output load	nom	330 kOhm
Absolute output current	max	± 0.4 mA
Operating / Storage temperature	nom	-25 ... +85°C
Window cap		All InfraTec windows and filters are available (except KBr and CsI). Customized filters upon request.

InfraTec reserves the right to change these specifications at any time without notification!  
© InfraTec GmbH, November 04<sup>th</sup> 2005

## InfraTec GmbH

Infrarotsensorik und Messtechnik  
Gostritzer Str.61-63

01217 Dresden / Germany

E-Mail: sensor@InfraTec.de  
http://www.InfraTec.de

distributed by:

ELECTRO OPTICAL COMPONENTS, Inc.

5460 Skylane Blvd.

Santa Rosa, California 95403

Tel: 707-568-1642

Fax: 707-568-1652

E-Mail: info@eoc-inc.com

http://www.eoc-inc.com

