



Electro Optical Components, Inc.

5464 Skylane Boulevard, Suite D, Santa Rosa, CA 95403

Toll Free: 855-EOC-6300

www.eoc-inc.com | info@eoc-inc.com



Mid-Infrared (MIR) Photodiode

1.1 - 2.46 μm



Lms24PD-10-R-PA and Lms24PD-10-RW-PA

Device parameters	Symbol	Value	Units
Sensitive area diameter	d	1,0	mm
Storage temperature	T _{stg}	-50..+80*	°C
Operating temperature	T _{opr}	0..+50*	°C
Reverse voltage	operates unbiased		

*PD design for higher storage/operating temperature is available under request

Photodiode parameters	Conditions	Symbol	Value	Units
Cut-off wavelength	T = 25 °C	λ_{cut}	2.40-2.46	μm
Max. sensitivity range (>80%)	T = 25 °C	λ_p	1.4-2.2	μm
Dark current	T = 25 °C; V _r = 1 V	I _d	100-300	μA
Shunt resistance	T = 25 °C; V _r = 10 mV	R _{sh}	1-3	k Ω
Capacitance	T = 25 °C; $\lambda = \lambda_p$	C	1000-1500	pF
Sensitivity	T = 25 °C; $\lambda = \lambda_p$	S	0.8-0.9	A/W
Noise equivalent power	T = 25 °C; $\lambda = \lambda_p$	NEP	(2.5-5.0)*10 ⁻¹²	W/Hz ^{1/2}
Detectivity	T = 25 °C; $\lambda = \lambda_p$	D*	(2.0-3.5)*10 ¹⁰	cm ² Hz ^{1/2} W ⁻¹

Photodiodes Lms24PD-10 series are fabricated from narrow band-gap GaInAsSb/AlGaAsSb-based heterostructures lattice matched to GaSb substrate.

All specifications are for photodiode operation at 25°C unless otherwise stated

Typical spectral response

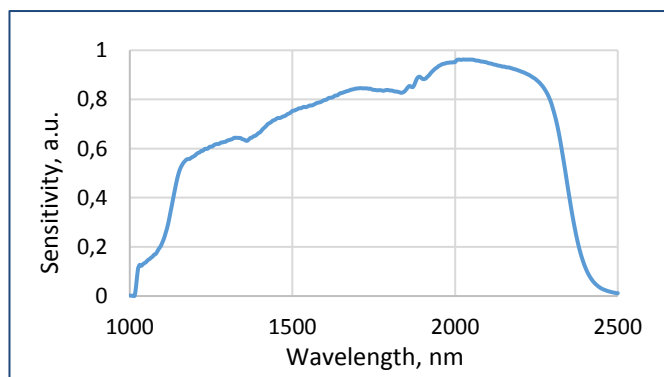

Temperature shift of spectral response

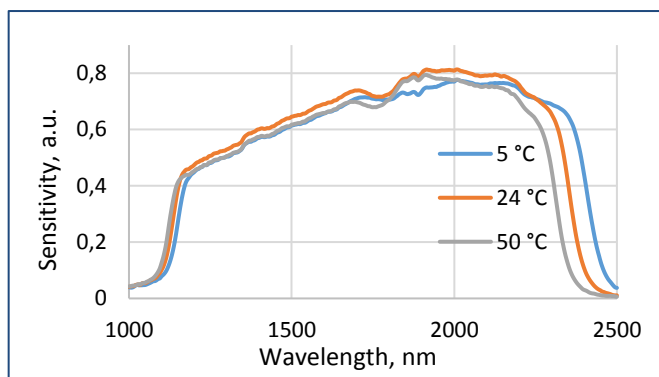

Typical current-voltage characteristic

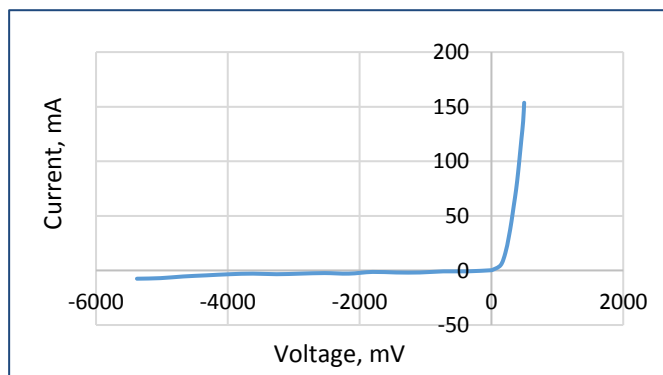

Packages	Model
TO-18 with a cap without a glass window	Lms MIR PD-10
TO-18 with a parabolic reflector without a window	Lms MIR PD-10-R
TO-18 with a parabolic reflector with a glass window	Lms MIR PD-10-RW
TO-5 with a built-in thermocooler and thermoresistor, covered by a cap with a glass window	Lms MIR PD-10-TEM
TO-5 with a built-in thermocooler and thermoresistor, covered by a parabolic reflector with a glass window	Lms MIR PD-10-TEM-R
PD with a built-in preamplifier; TO-18 with a parabolic reflector without a window in an aluminium tube	Lms MIR PD-10-R-PA
PD with a built-in preamplifier; TO-18 with a parabolic reflector with a window in an aluminium tube	Lms MIR PD-10-RW-PA

Mode of operation of photodiode with preamplifier

Standard photodiodes work in two modes of operation: photoconductive (with reverse bias) and photovoltaic (with zero bias). When photodiode works in photovoltaic mode it becomes the source of current.

Photodiode models with LMSNT preamplifier (-PA) work in photovoltaic mode. Current generated by photodiode is amplified and converted by preamplifier into voltage signal. There is straight correspondence between PD current and resulting output voltage. The signal converted by preamplifier will have the same form, frequency and pulse duration as the photocurrent signal from photodiode. Current into voltage conversion coefficient is constant and depends on given photodiode.

NOTE! Preamplifier is typically tuned for operation with an emitter working in a pulse mode with 0.5 kHz frequency and 20 μs pulse duration. Tuning for other operation modes is available under special request.

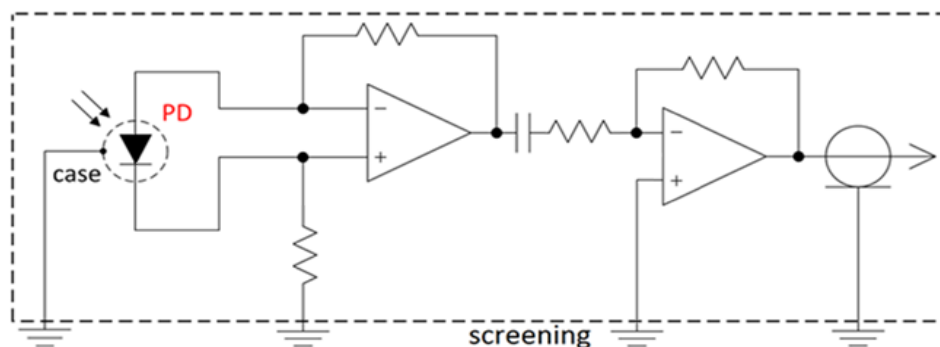

Connections:

The output of PD with a built-in preamplifier has four wires:

- "+" power input (to the "+" of the power output terminal block of the SDM synchronous detector);
- "-" power input (to the "-" of the power output terminal block of the SDM synchronous detector);
- output photodiode signal (to the "-" of the signal input terminal block of the SDM synchronous detector);
- output photodiode signal (to the "+" of the signal input terminal block of the SDM synchronous detector).

For the proper connection mind colours of the wires pointed in the technical data provided with the photodiode.

IMPORTANT CAUTIONS:

- please check your connection circuit before turning on the PD;
- please do not connect the PD to the multimeter.

Technical Drawings

Lms24PD-10-R-PA

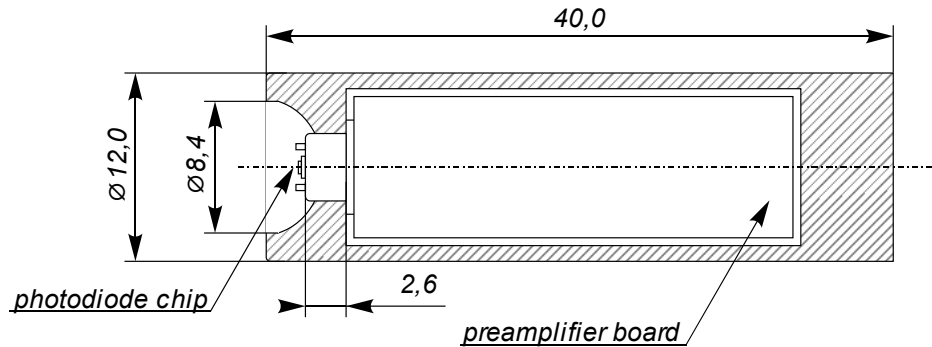

Lms24PD-10-RW-PA

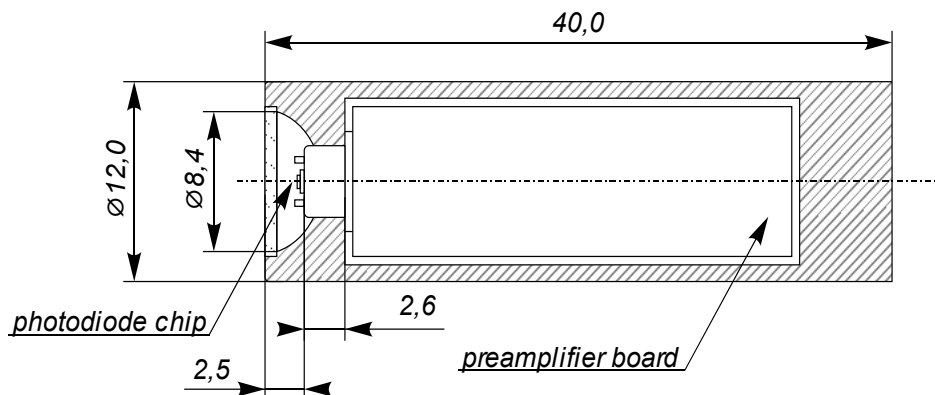

Related products:

- **LEDs** - sources of mid-infrared radiation;
- **SDM** - synchronous detector for PD models with preamplifiers - Lms MIR PD-XX-R-PA and Lms MIR PD-XX-RW-PA. SDM synchronous detector measures the voltage signal from the output of photodiode preamplifier and converts it to the DC voltage signal proportional to amplitude of voltage from input.
- **TCM** - thermocontroller for PD models with built-in thermoelectric modules (thermocooler and thermistor) - Lms MIR PD-XX-TEM and Lms MIR PD-XX-TEM-R models. TCM enables control and adjustment of PD temperature.