



## Reflective Spatial Light Modulator FSLM-2K73-P03

### 1. Main parameters

Model	FSLM-2K73-P03	Modulation	Phase-only
LCOS type	Reflection	Grayscale level	8 bits, 256 steps
Number of Pixels	2048×2048	Image Size	6.4μm
Effective area	0.73" 13.1mm×13.1mm	Response time	≤30ms
Fill factor	93%	Optical Utilization	≥85%
Gamma correction	Support	Modulation depth	2π@633nm
Phase linearity	≥0.999	/	/
Refresh frequency	60 Hz @color	Spectral range	1000nm-1100nm
Damage Threshold	20W/cm <sup>2</sup>	Data Interface	HDMI

### 2. Basic operation

Start the computer.

Connect the components as shown in the figure below (connect the power adapter last).

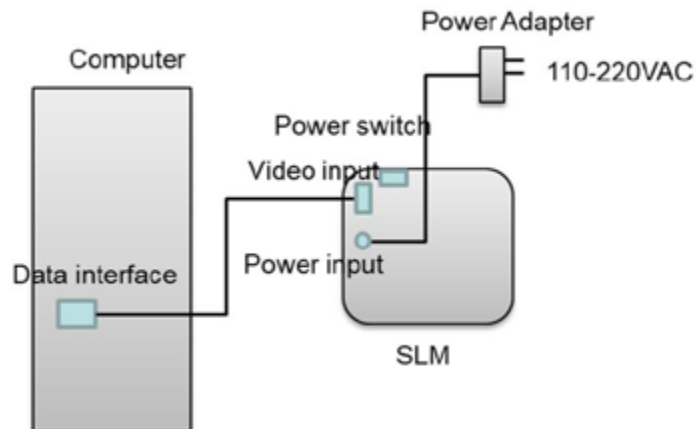

Diagram of the connection of each component

Notes:

1. Connect the video cable at first, and then connect the power cable.
2. The power supply of the space light modulator is a special power supply, do not mix with other power supplies to prevent damage to the modulator.

Take Windows system as an example. First, right-click on the desktop, click "Screen Resolution" to identify the current monitor. And then, click another monitor, set the screen resolution to  $2048 \times 2048$ . After that, set the "Multi-monitor" to "expand these displays", and click "Apply". At last, click "OK", at this point to complete the desktop image to expand the second monitor settings.

Observe the picture displayed on the spatial light modulator monitor and ensure that the picture on the computer desktop expands smoothly to the second monitor. If the image is not normal, re-plug the power adapter or check other wiring.

Fix the SLM on the optical platform with the configured bracket. If you do not use the bracket, you can use 2 M6 screws to connect the spatial light modulator to the base (note: try to use the screws configured with the equipment, using too long screws can easily damage the board and damage the modulator), and then fixed on the optical platform.

Build the required light path.

Change the desktop image as needed. the way is that: right-click on the desktop --- click on "Personalize" --- click on "Desktop Background" at the bottom --- find the desired image and click on it. And then, set the "Image Position" as needed, and generally recommend setting it to "Tile" is recommended. You can also directly find the desired extended image, right-click, click "Set as desktop background" (It is recommended to use the same resolution as the SLM resolution of the image).

The SLM control software developed by our company can also be used to control the image on the extended to SLM.

Notes:

Do not dismantle the machine and rotate the deflector and deflector by yourself to avoid affecting the working condition of the modulator.

Do not touch the deflector and detector with your hands. If there is dust, blow it off gently with an air ball.

If there is any stain, use a cotton swab with a mixture of alcohol and ether (3:1) to wipe it with better effect.

### 3. Typical optical path

Path one :

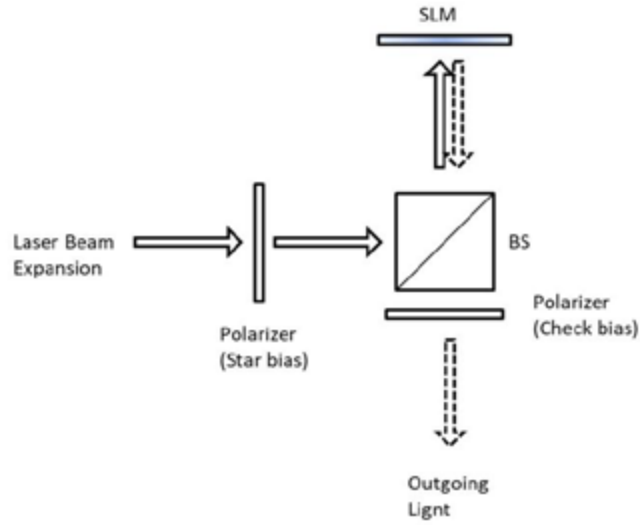

Path two :

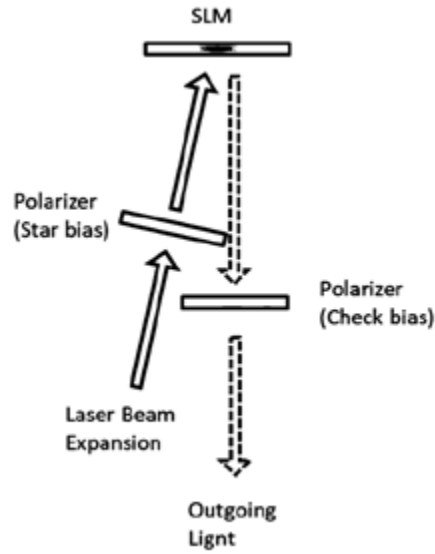

## 4. Software Introduction

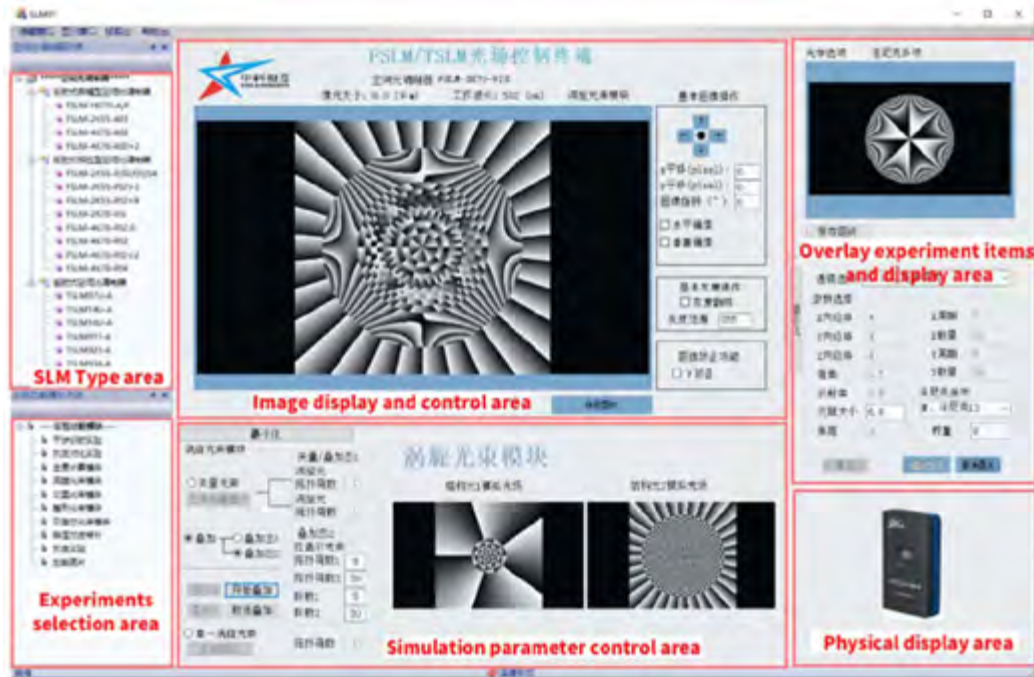

C/C++ based development, running environment: Windows 7 sp1 and above, 32bits/64bits.

Suitable for all types of our SLM.

The overall interface of the software consists of 6 parts:

SLM type area : For presenting all types of our existing SLMs.

Experiments selection area : Used to present the current SLM can support the experiment options, the users can choose according to the actual needs.

Image display and control area : The image display area is used to present the grayscale map corresponding to the experiment selection item, and the control area is used to control the image panning, inversion, correction and other functions.

Simulation parameter control area : Experimental parameters control panel for presenting the corresponding experimental options, with flexible and adjustable parameters.

Overlay experiment items and display area : For presenting the corresponding experiment selection module, the experiment parameter control panel and the corresponding grayscale map.

Physical display area : For showing the physical diagram of the corresponding SLM ;

Integration of various specific light field control functions ;

Diffractive light fields: single slits, gratings, etc.

diffraction-free light fields: Bessel, Airy beams, etc.

structured light fields: vortex and vortex-beam superposition states.

Light field modulation: holography, shaping, etc.

The experimental projects supported by the amplitude type include: double-slit interference experiment, heterodyne diffraction experiment, grayscale comparison experiment and Fresnel wave band slice experiment.

The experimental items supported by the phase type are divided into module items and experimental items, which include: computational holography module, vortex beam module, shaping beam module, Airy beam module and Bessel beam module, and experimental items include: Fresnel lens, cylindrical wave lens, axial prismatic cone lens, shine grating, Damen grating and aberration correction.

Real-time online adjustment and control of various light field parameters.

Fast correction of wavefront aberration according to actual needs.

Autonomous expansion for dynamic display in external input mode.

Choose your own playback mode to achieve high-speed refresh playback.

Green mode with no installation, just unzip and run.

Open program interface, the software opens the function interface of image processing part in the form of SDK, including various picture selection methods, playback control of multicast pictures and window management functions, developers can carry out basic image control programming operations according to the function functions provided by the interface;

SDK supports various development languages, including Labview, C/C++, C#, VB, python, Matlab, and provides complete Demon program.

Encryption software: Software and encryption locks interact in cipher text to transmit data.

Open module functions are available for a fee, including shaped beam, vector beam, vortex superposition, and lens superposition.

Other functions can be developed according to customer requirements.