



Electro Optical Components, Inc.

5460 Skylane Boulevard, Santa Rosa, CA 95403

Toll Free: 855-EOC-6300

www.eoc-inc.com | info@eoc-inc.com



Product Data Sheet

SiPM – Silicon Photomultiplier Module

with integrated Transimpedance Amplifier and Bias Source

PE3315-WB-TIA-SP / PE3325-WB-TIA-SP

PE3315-WB-TIA-TP / PE3325-WB-TIA-TP

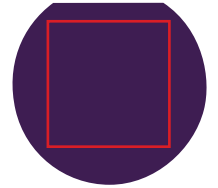

KETEK



Key Features Overview

- PM3315-WB or PM3325-WB SiPM based
- Integrated Transimpedance Amplifier (TIA)
- Integrated Controllable Bias Source for SiPM
- Optionally with integrated Gain Stabilization
- Plug and Play Solution to replace PMTs
- Compatible with Thorlabs® SM05 Optics, 16 mm Optical Cage Systems, Hamamatsu® PMT mounts

Application Examples



Biophotonics

- Cytometry
- Fluorescence Measurements
- Point-of-Care Diagnostics



Hazard & Threat Detection

- Single Photon Counting
- Scintillator Readout
- Handheld Devices



High Energy Physics

- Low Light Level Detection
- High Linearity Measurements
- Energy Measurements

General Parameters and Order Information

SiPM Type ^A	Active Area [mm ²]	Microcell Size [μm]	No. of Microcells	Gain stabilized vs. Temperature	Order-Code
PM3315-WB-C0	3.0 x 3.0	15	38800	No	PE3315-WB-TIA-SP
				Yes	PE3315-WB-TIA-TP
PM3325-WB-D0	3.0 x 3.0	25	13920	No	PE3325-WB-TIA-SP
				Yes	PE3325-WB-TIA-TP

Recommended Operation Parameters

Parameter	Description
Ctrl Voltage PE33xx-WB-TIA-xP	0.7 V (resulting SiPM over voltage of about 5 V)
Operating Temperature	0°C - 60 °C

Electrical and Optical Characteristics at 21°C (typ.)

Module Type ^A	Photo Detection Efficiency [%]	Dark Count Rate [kHz/mm ³]	Crosstalk Probability [%]	Afterpulsing Probability [%]	Recovery Time [ns]
PE3315-WB-TIA-xP @ Ctrl = 0.7 V	31 (@ 430 nm)	125	18	5	15
PE3325-WB-TIA-xP @ Ctrl = 0.7 V	45 (@ 430 nm)	125	26	<1	35

^A Full SiPM specification can be found in the corresponding SiPM datasheet, please visit www.ketek.net/sipm-downloads



Product Data Sheet

SiPM – Silicon Photomultiplier Module

with integrated Transimpedance Amplifier and Bias Source

PE3315-WB-TIA-SP / PE3325-WB-TIA-SP

PE3315-WB-TIA-TP / PE3325-WB-TIA-TP

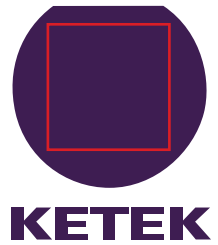

Interfaces and Electrical Ratings

Parameter	Description
Outer Dimensions	40.0 x 50.0 x 19.8 mm ³ (L x W x H)
Mechanical Compatibility	Thorlabs® SM05 Optics and 16 mm cage system Hamamatsu® PMT mounts
Power Supply Input	+5 V DC (± 0.5 V, max + 12 V DC), 300 mA, MCX connector Recommended ripple noise < 10 mV
Typical Power Consumption	350 mW (69 mA @ 5 V power supply)
Bias Voltage / Gain Control (Ctrl)	0 V to +1 V (min. -0.2 V, max. +1.2 V), 50 mA, MCX connector
Signal Output (Signal)	Output range 0 V to +1 V, positive polarity, MCX connector matched to 50 Ω impedance
Max. recommended Cable Length	3 m

Electrical Characteristics of Signal Output

Parameter	Description
Transimpedance Amplifier Gain	2 stage design, total gain 150 V/A
Signal Output Bandwidth	12.5 MHz
Signal Output Amplitude Noise	500 μV (σ, AC coupled, 20 MHz bandwidth)
Bias Voltage / Gain Control (Ctrl)	0 V to +1 V, 50 mA, MCX connector
Output Offset Tuning Range	Preset to 0 V, upon request -1 V to 0 V
Output Offset Drift with Temperature	< 0.5 mV/K

Electrical Characteristics of Internal SiPM Bias Supply

Parameter	Description
Bias Voltage Range PE3315-WB-TIA-xP	26.81 V to 34.00 V (SiPM V_{bd} at typ. 26.9 V @ 21°C, no internal SiPM amplification below V_{bd})
Bias Voltage Range PE3325-WB-TIA-xP	24.69 V to 31.55 V (SiPM V_{bd} at typ. 24.7 V @ 21°C, no internal SiPM amplification below V_{bd})
Ripple Noise	< 2 mV min-max (1 MΩ input resistance, 22 pF capacitive load, 0.5 m RG-174-U cable)
Stability	< 5 mV min-max (f = 0.1 Hz)
Input Impedance	400 kΩ
Settling Time	0.5 s (time to reach stable SiPM bias after change of Ctrl voltage)
Output Current Limit	10 mA

Typical Performance Characteristics

SiPM Bias Voltage vs. Ctrl Voltage
PE3315-WB-TIA-xP

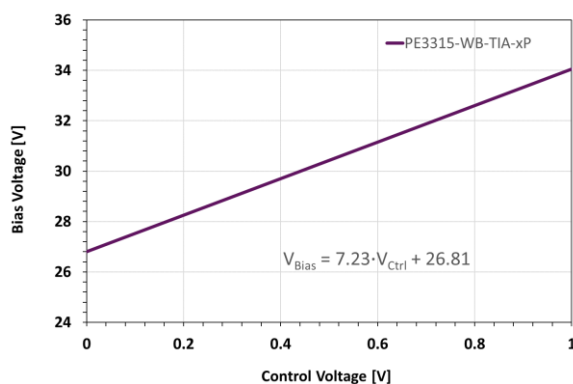

SiPM Bias Voltage vs. Ctrl Voltage
PE3325-WB-TIA-xP

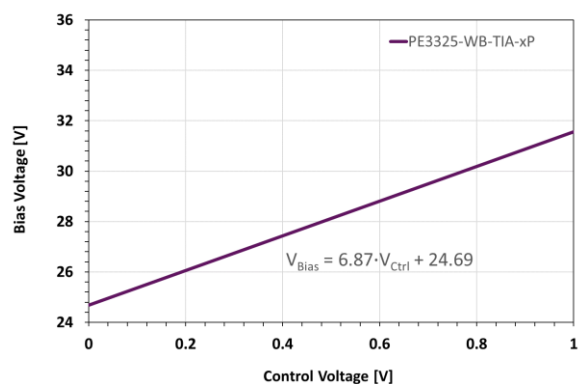

Product Data Sheet

SiPM – Silicon Photomultiplier Module

with integrated Transimpedance Amplifier and Bias Source

PE3315-WB-TIA-SP / PE3325-WB-TIA-SP

PE3315-WB-TIA-TP / PE3325-WB-TIA-TP

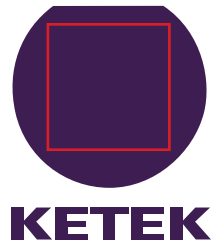

Normalized SiPM Gain vs. Temperature
Comparison of PE33xx-WB-TIA-SP and PM33xx-WB-TIA-TP

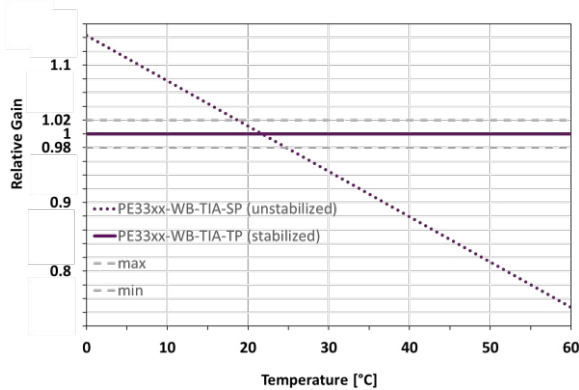

Single Photon Spectrum Example

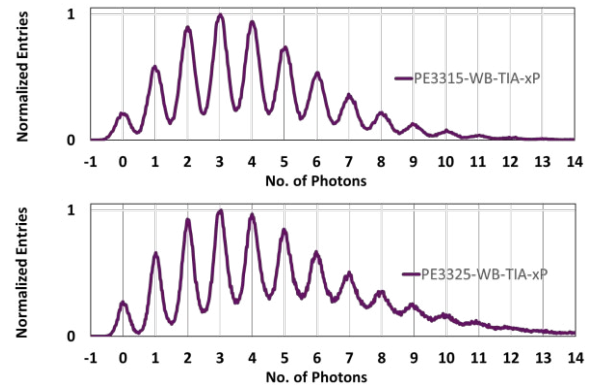

Mechanical Specifications

Dimensions^B

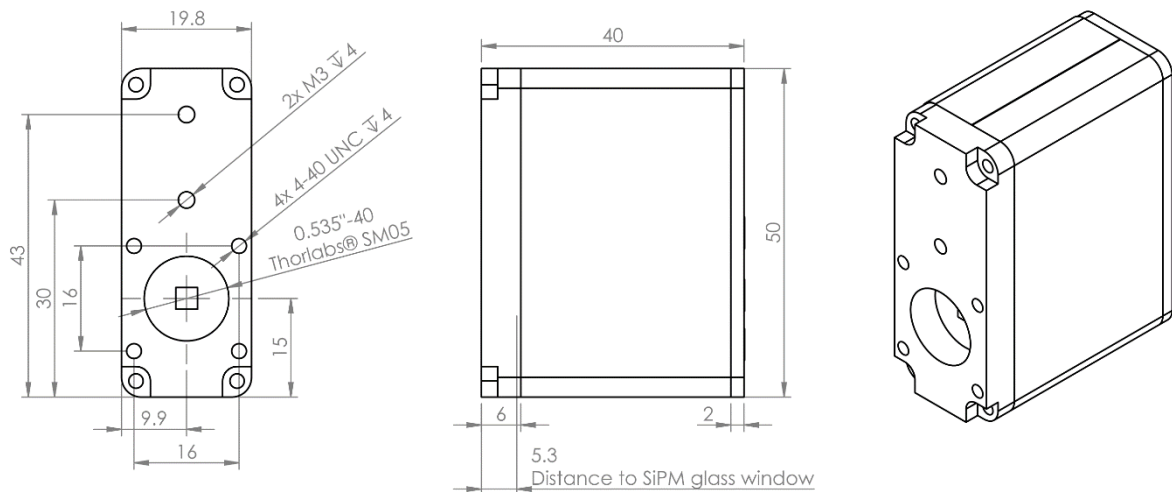

^B General tolerances ± 0.1 mm unless otherwise noted

Revision History

Revision and Date	Changes
Rev. 2020-A February 2020	Added "Application Examples" and "Electrical and Optical Characteristics at 21°C and Ctrl = 0.7 V (typ.)" Updated "General Parameters and Order Information" Updated plot design, added "Normalized SiPM Gain vs. Temperature" and "Single Photon Spectrum Example" Updated "Dimensions" technical drawing
Rev. 2019-A December 2019	Initial release

Important Notice

KETEK reserves the right to make changes without further notice to any products herein. KETEK makes no warranty, representation or guarantee regarding the suitability of its products for any particular purpose, nor does KETEK assume any liability arising out of the application or use of any product or circuit, and specifically disclaims any and all liability, including without limitation special, consequential or incidental damages. "Typical" parameters which may be provided in KETEK data sheets and/or specifications can and do vary in different applications and actual performance may vary over time. All operating parameters, including "Typical" must be validated for each customer application by customer's technical experts. KETEK does not convey any license under its patent rights nor the rights of others. KETEK products are not designed, intended, or authorized for use as components in applications in which the failure of the KETEK product could create a situation where personal injury or death may occur. Should Buyer purchase or use KETEK products for any such unintended or unauthorized application, Buyer shall indemnify and hold KETEK and its officers, employees, subsidiaries, affiliates, and distributors harmless against all claims, costs, damages, and expenses, and reasonable attorney fees arising out of, directly or indirectly, any claim of personal injury or death associated with such unintended or unauthorized use, even if such claim alleges that KETEK was negligent regarding the design or manufacture of the part.