



RoHS Compliant
ISO 9001
Certified

LED MICROSENSOR NT, LLC						
LED MICROSENSOR NT, LLC Model Number	Andon Part Number Replace "XXX" with Terminal Type	Terminal Type		Pin Ø [in]	Figure Number	Page Number
		Thru-Hole	Surface Mount			
LMS MIR PD-03	R100-0403-07T-XXX-R27-L14	211S	384S	.018	1	1
LMS MIR PD-03-RW	R100-0403-07T-XXX-R27-L14	211S	384S	.018	1	1
LMS MIR PD-05	R100-0403-07T-XXX-R27-L14	211S	384S	.018	1	1
LMS MIR PD-10	R100-0403-07T-XXX-R27-L14	211S	384S	.018	1	1
LMS43LED-4M	R100-0403-07T-XXX-R27-L14	211S	384S	.018	1	1
LMS MIR PD-03-TEM	R200-0806-05T-XXX-R27-L14	75S	265S	.018	2	1
LMS MIR PD-03-TEM-R	R200-0806-05T-XXX-R27-L14	75S	265S	.018	2	1
LMS MIR PD-03-R-PA	R200-0806-05T-XXX-R27-L14	75S	265S	.018	2	1
LMS MIR PD-05-TEM	R200-0806-05T-XXX-R27-L14	75S	265S	.018	2	1
LMS MIR PD-10-TEM	R200-0806-05T-XXX-R27-L14	75S	265S	.018	2	1
LMS MIR LED	R200-0806-05T-XXX-R27-L14	75S	265S	.018	2	1
LMS MIR LED-R	R200-0806-05T-XXX-R27-L14	75S	265S	.018	2	1
LMS MIR LED-RW	R200-0806-05T-XXX-R27-L14	75S	265S	.018	2	1
LMS MIR LED-TEM	R200-0806-05T-XXX-R27-L14	75S	265S	.018	2	1
LMS MIR LED-TEM-R	R200-0806-05T-XXX-R27-L14	75S	265S	.018	2	1
LMS18LED-TO-8	R375-SP16-01T-XXX-R27-L14	75S	265S	.018	3	2
LMS19LED-TO-8	R375-SP16-01T-XXX-R27-L14	75S	265S	.018	3	2
LMS20LED-TO-8	R375-SP16-01T-XXX-R27-L14	75S	265S	.018	3	2
LMS21LED-TO-8	R375-SP16-01T-XXX-R27-L14	75S	265S	.018	3	2
LMS22LED-TO-8	R375-SP16-01T-XXX-R27-L14	75S	265S	.018	3	2
LMS23LED-TO-8	R375-SP16-01T-XXX-R27-L14	75S	265S	.018	3	2
LMS MIR PD-03-RW-PA	R200-0806-05T-XXX-R27-L14	75S	265S	.018	2	1
LMS MIR PD-05-TEM-R	R200-0806-05T-XXX-R27-L14	75S	265S	.018	2	1
LMS MIR PD-10-TEM-R	R200-0806-05T-XXX-R27-L14	75S	265S	.018	2	1
LMS MIR PD-05-R	R100-0403-07T-XXX-R27-L14	211S	384S	.018	1	1
LMS MIR PD-05-RW	R100-0403-07T-XXX-R27-L14	211S	384S	.018	1	1
LMS MIR PD-10-R	R100-0403-07T-XXX-R27-L14	211S	384S	.018	1	1
LMS MIR PD-10-RW	R100-0403-07T-XXX-R27-L14	211S	384S	.018	1	1
LMS34LED-4M	R100-0403-07T-XXX-R27-L14	211S	384S	.018	1	1
LMS XXLED	R100-0402-03T-XXX-R27-L14	75S	265S	.018	4	2
LMS XXLED-R	R100-0402-03T-XXX-R27-L14	75S	265S	.018	4	2
LMS XXPD-XX	R100-0402-03T-XXX-R27-L14	75S	265S	.018	4	2
LMS XXPD-XX-R	R100-0402-03T-XXX-R27-L14	75S	265S	.018	4	2

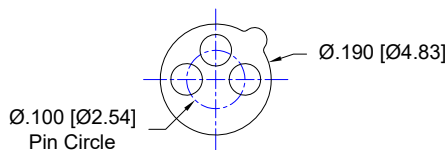

FIG: 1

Thru-Hole: R100-0403-07T-211S-R27-L14
Surface Mount: R100-0403-07T-384S-R27-L14

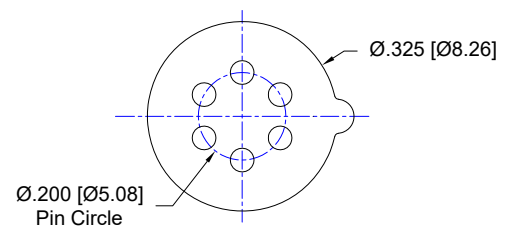

FIG: 2

Thru-Hole: R200-0806-05T-75S-R27-L14
Surface Mount: R200-0806-05T-265S-R27-L14

LED MICROSENSOR NT, LLC *Continued*

Socket Terminal Details Cross Section View Shown Units: in [mm]

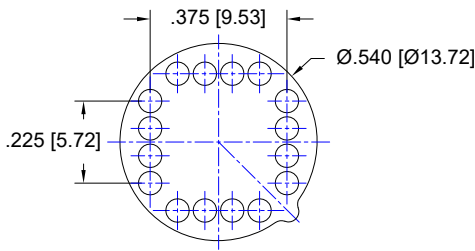

FIG: 3
Thru-Hole: R375-SP16-01T-75S-R27-L14
Surface Mount: R375-SP16-01T-265S-R27-L14

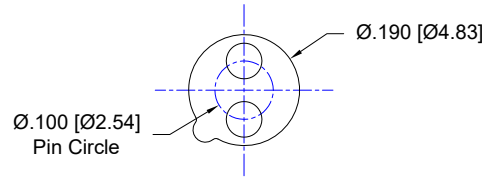
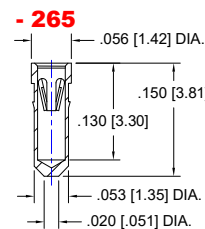
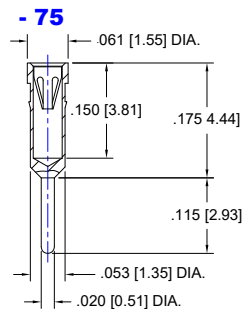
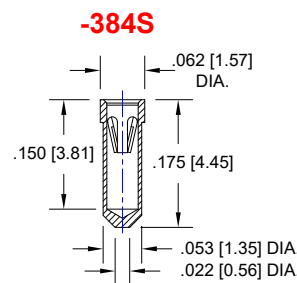
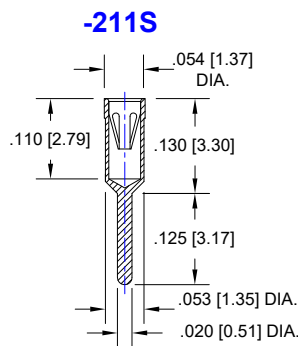

FIG: 4
Thru-Hole: R100-0402-03T-75S-R27-L14
Surface Mount: R100-0402-03T-265S-R27-L14



Technical Information

Material:

Insulator: Hi-Temp UL 94V-O
Terminal: Brass, per ASTM-B16
Contact: BeCu, Per ASTM-B194

Plating: RoHS COMPLIANT

R15 TERMINAL: GOLD / CONTACT: GOLD

R17 TERMINAL: TIN / CONTACT: GOLD

OTHER PLATINGS AVAILABLE

Terminal Acceptance and Forces

Thru Hole Terminals				Surface Mount Terminals			
Thru Hole Terminal	Accepts Pin Diameter	Insertion Force	Withdrawal Force	Surface Mount Terminal	Accepts Pin Diameter	Insertion Force	Withdrawal Force
-75S	Ø.018 [Ø0.46]	9.0 oz Avg.	2.0 oz Min	-265S	Ø.018 [Ø0.46]	9.0 oz Avg.	2.0 oz Min
-211S	Ø.018 [Ø0.46]	9.0 oz Avg.	2.0 oz Min	-384S	Ø.018 [Ø0.46]	9.0 oz Avg.	2.0 oz Min

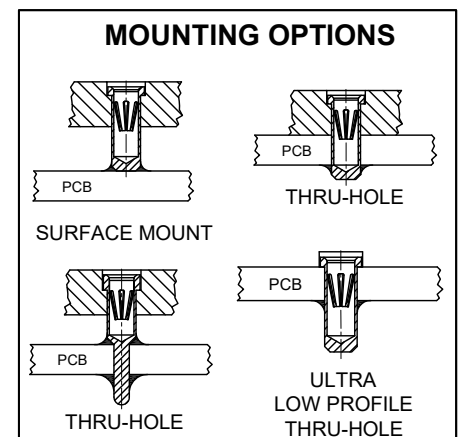

"ANDON PROPRIETARY INFORMATION"

RoHS Compliant

©Copyright 2015 Andon Electronics Corporation. All Rights Reserved. This material is protected under US and other copyrights and may not be copied, sold, or redistributed in any form without written permission of Andon Electronics Corporation. Copyrights and trademarks are property of their respective companies. We reserve the right to change specifications without notice. Andon makes no warranty, expressed or implied, as to the suitability of the sockets for the intended purpose.

*Sockets are not drawn to scale LED MICROSENSOR NT, LLC 03/04/2015